

Setting Up

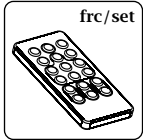

Setup Remote Control – frc/set

The sensor can only be setup by using an **frc/set** remote control - ordered separately.

Optional Extras

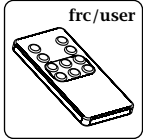

User Remote Control – frc/user

The **frc/user** remote control is a convenient method for the user to control the lighting remotely. Lights can be temporarily overridden ON or OFF and in cases where the lighting control is dimmable, dimmed UP or DOWN. In addition, up to six preset light levels can be stored and recalled.

Note: Unlike the **frc/set** remote control the **frc/user** remote control can not be used

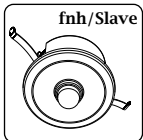

Increasing Occupancy Coverage – fnh/slave

Occupancy coverage can be increased by adding up to a maximum of five slave sensor heads (**fnh/slave**) to your existing sensor head. The **fnh/slave** comes complete with a 'Y' adaptor to facilitate connection.

fns3400D(X, A)/AT Absence with Daylight Linking Sensor Kit

J

The **fns3400D(X, A)/AT** sensor kit plugs directly into any of the **flex7** 7-pole range of connection units or a 7-pole single socket outlet to provide control of the connected mains rated luminaires. Control is ON/OFF/DIM and is dependent on a combination of occupancy detection, light level detection and an initiating / overriding wall switch (operating at ELV). The kit comprises a controller, sensor head, sensor lead and a switch drop lead.

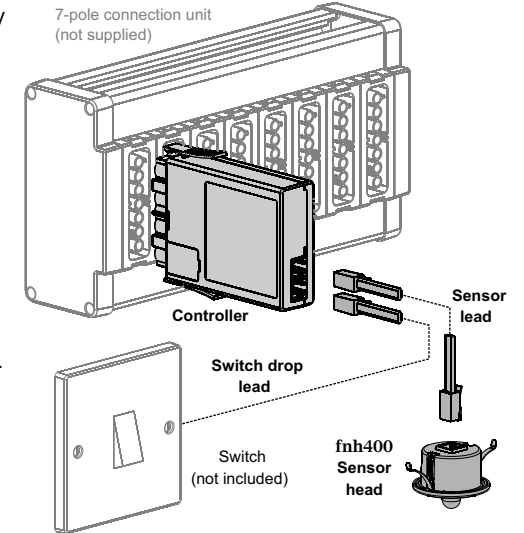

Three products are available:
fns3400D/AT for DSI digital dimmable ballasts.
fns3400X/AT for DALI digital dimmable ballasts.
fns3400A/AT for Analogue ballasts 0-10V.

This product should only be

Considerations before installation

The **fnh400** sensor head detects both occupancy and light level. However, conditions for optimum light sensing should always have priority over those for occupancy coverage. To achieve effective daylight linking control, select only an area where the daylight contribution, though changeable, is significant and remains consistent across the area.

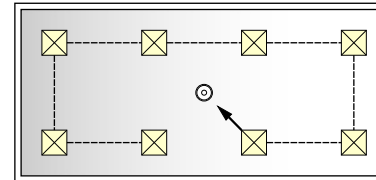

As lamp output across the circuit must be common, it is not possible to provide the 'optimal' luminosity for all areas when some receive more daylight than others.

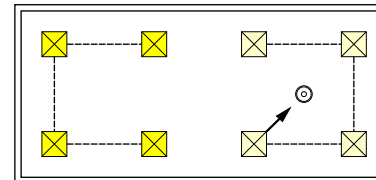
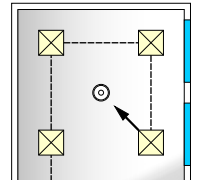

Try to split into zones where the changes in daylight are reasonably consistent. Darker areas may then be controlled via alternative means such as on/off without consideration to light level. You may even consider sufficient natural light reaches these areas to justify a second light level sensing circuit.

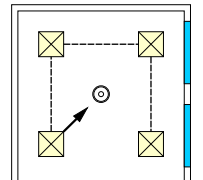

Note: Always fit the sensor head as close as possible to the centre of the group of lights under its control. Do not site where the head could receive direct sunlight.

Sensor head and occupancy detection performance

fnh400

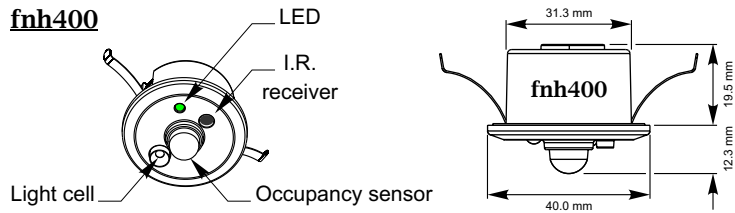

The sensor head fits into a 32mm diameter hole, with clips which can grip ceiling panels down to 1.5mm thick.

The sensor head has a rectangular occupancy detection range broadly 7.4m x 5.6m at a ceiling height of 2.5m (Longest length of detection aligning with the spring clips). As the ceiling height increases so will the overall detection area but sensitivity to small movements will decrease.

Note: MAke sure that the sensor is not adjacent to circulating air, heaters or lamps.

Detection Zone

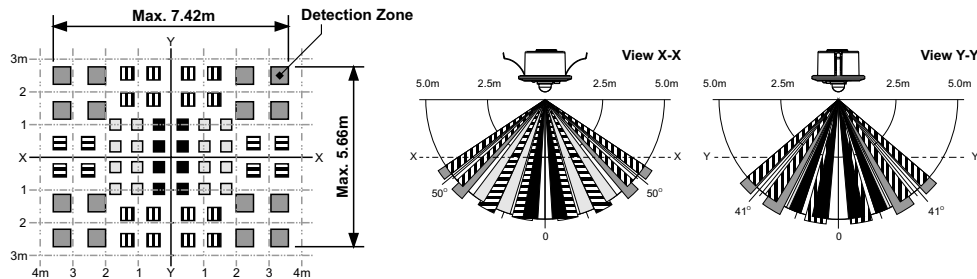

The X-Y cross-sectional diagram shows the detection area. The differences in the detection zone patterns indicate the projections of the 16 lenses with a single focal point. Movement of an object with higher than background temperature, between the detection zones, will be detected.

Configuring the controller and wiring the connection unit

Prise open lid 'C' using a screw driver. Position link as required.

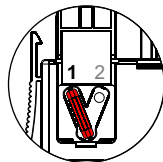
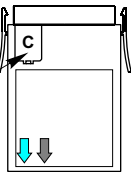

Link in position 1

Lights can remain ON during an emergency test. Wire connection unit as shown in option A. See 'Wiring' opposite for details.

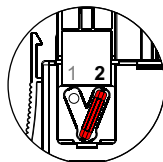

Link in position 2

Lights will switch OFF during an emergency test. Wire connection unit as shown in option A or B. See 'Wiring' opposite for details.

Rating

Supply Voltage : 220V-240V, 50Hz, ~

Load

Flourescent & Incandescent Lighting : 6A
Compact Flourescent Lighting : 3A

Maximum number of Ballast

fns3400D/AT (DSI Digital control) : 25
fns3400X/AT (DALI Digital control) : 25

Wiring

* Core colours if using 5 & 6-core flex7 pre-wired plug and leads

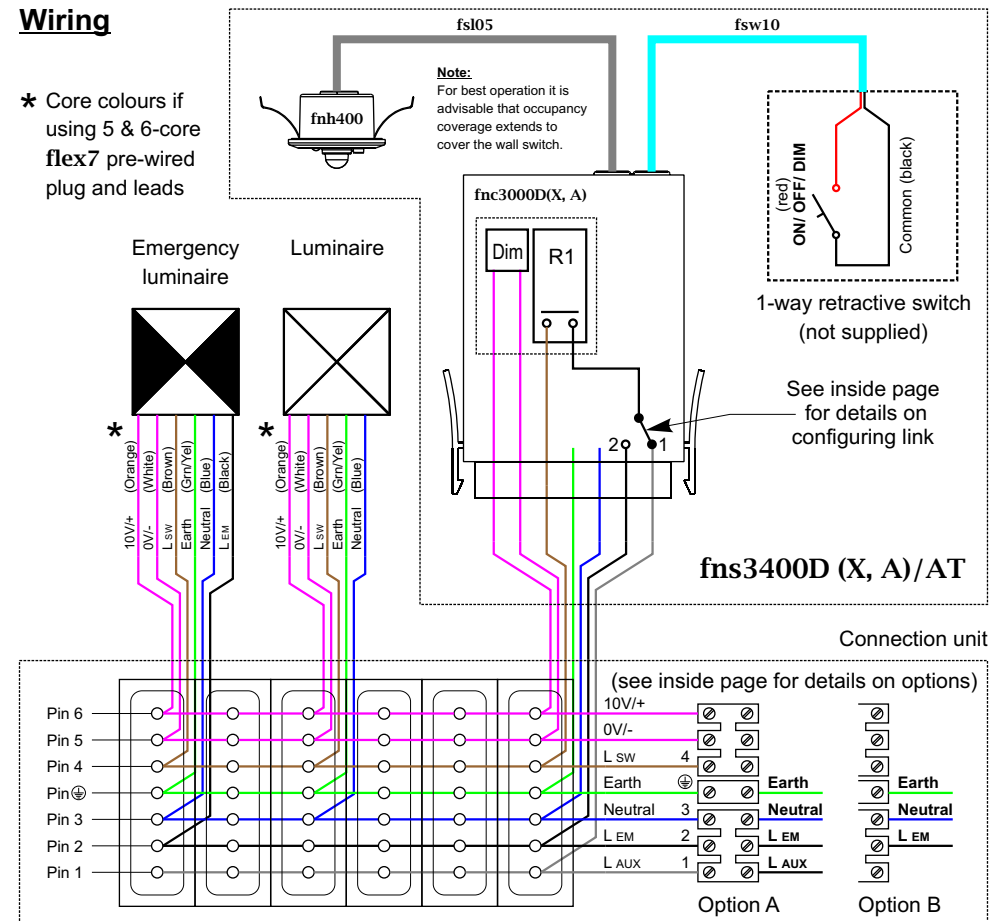

Operation:

Switch control: A short pulse (<0.5 secs)

Toggles the lights ON or OFF (when turning ON, lights will be daylight linking).

Along pulse (>0.5 secs)

Alternates from brightening the lights to dimming the lights with each consecutive long pulse. **Note:** Manual dimming temporarily disables daylight linking.

A prolonged pulse (>15 secs)

Synchronizes the lights to OFF.

Absence detection: When occupancy is no longer detected, lights will switch OFF after a pre-selected time-out period (default 20 minutes)

Daylight linking: Provided *daylight linking* is activated (see above) the light output will adjust to compensate for any changes in ambient light in order to maintain a constant light level under the sensor head, the *target-level*. **Note:** Alternative operational options not necessarily shown above are available using the frc/set setup remote control.

Note: Multiple switches can be connected in parallel. For each additional switch you will require: 1 x fsy/a- 'Y' adaptor)