

Setting Up



Setup Remote Control – frc/set

The sensor can only be setup by using an **frc/set** remote control - ordered separately. Full instructions for setting up the sensor are supplied with the **frc/set** remote control.

Optional Extras

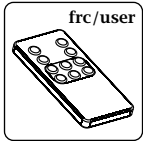

User Remote Control – frc/user

The **frc/user** remote control is a convenient method for the user to control the lighting remotely. Lights can be temporarily overridden ON or OFF and in cases where the lighting control is dimmable, dimmed UP or DOWN. In addition, up to six preset light levels can be stored and recalled.

Note: Unlike the **frc/set** remote control the **frc/user** remote control can not be used to setup or change occupancy time-out settings.

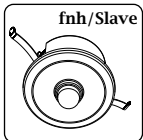

Increasing Occupancy Coverage – fnh/slave

Occupancy coverage can be increased by adding up to a maximum of five slave sensor heads (**fnh/slave**) to your existing sensor head. The **fnh/slave** comes complete with a 'Y' adaptor to facilitate connection.

A connecting lead may also be required, part number **fsLXX** (XX = length /5m).

fns3400D(X, A)/AB Absence with Daylight Linking Sensor Kit

P

The **fns3400D(X, A)/AB** sensor kit plugs directly into any of the **flex7** 7-pole range of connection units or a 7-pole single socket outlet to provide control of the connected mains rated luminaires. Control is ON/OFF/DIM, dependent on occupancy and light level detection. The kit comprises a controller, sensor head, and sensor lead.

Three products are available:

fns3400D/AB for DSI digital dimmable ballasts.

fns3400X/AB for DALI digital dimmable ballasts.

fns3400A/AB for Analogue ballasts 0-10V.

Please ensure the correct product is selected for the type of ballast being used as incorrect connection may damage the controller.

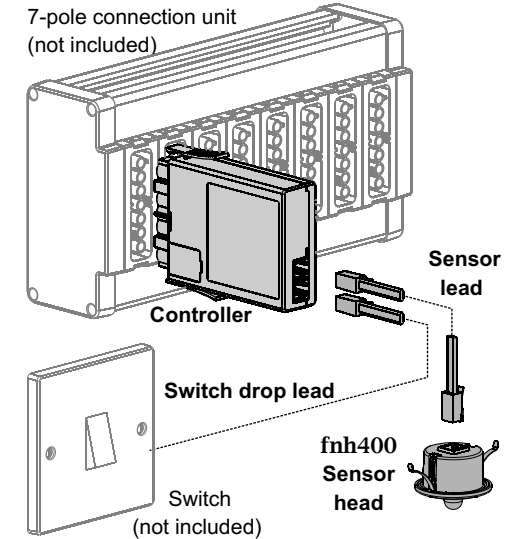

Considerations before installation

The **fnh400** sensor head detects both occupancy and light level. However, conditions for optimum light sensing should always have priority over those for occupancy coverage. To achieve effective daylight linking control, select only an area where the daylight contribution, though changeable, is significant and

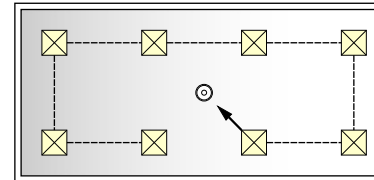

As lamp output across the circuit must be common, it is not possible to provide the 'optimal' luminosity for all areas when some receive more daylight than others.

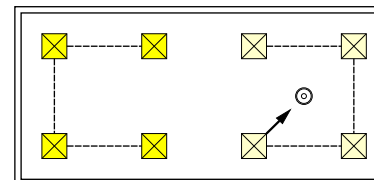
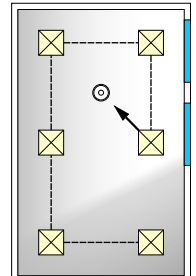

Try to split into zones where the changes in daylight are reasonably consistent. Darker areas may then be controlled via alternative means such as on/off without consideration to light level. You may even

consider sufficient natural light reaches these areas to justify a second light level sensing circuit.

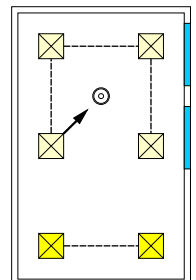

Sensor head and occupancy detection performance

fnh400

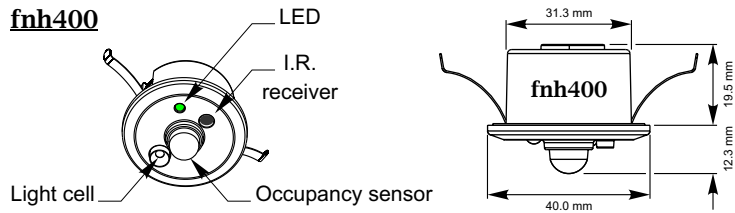

The sensor head fits into a 32mm diameter hole, with clips which can grip ceiling panels down to 1.5mm thick.

The sensor head has a rectangular occupancy detection range broadly 7.4m x 5.6m at a ceiling height of 2.5m (Longest length of detection aligning with the spring clips). As the ceiling height increases so will the overall detection area but sensitivity to small movements will decrease.

Note: MAke sure that the sensor is not adjacent to circulating air, heaters or lamps.

Detection Zone

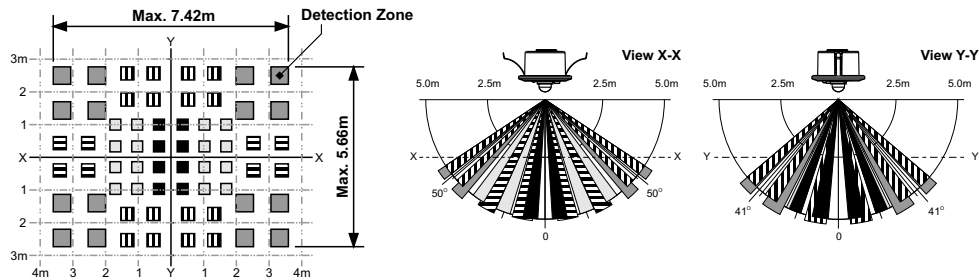

The X-Y cross-sectional diagram shows the detection area. The differences in the detection zone patterns indicate the projections of the 16 lenses with a single focal point. Movement of an object with higher than background temperature, between the detection zones, will be detected.

Configuring the controller and wiring the connection unit

Prise open lid 'C' using a screw driver. Position link as required.

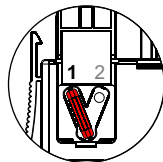
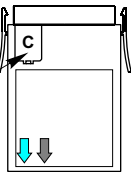

Link in position 1

Lights can remain ON during an emergency test. Wire connection unit as shown in option A. See 'Wiring' opposite for details.

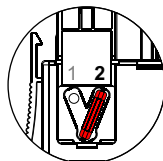

Link in position 2

Lights will switch OFF during an emergency test. Wire connection unit as shown in option A or B. See 'Wiring' opposite for details.

Rating

Supply Voltage : 220V-240V, 50Hz, ~

Load

Flourescent & Incandescent Lighting : 6A
Compact Flourescent Lighting : 3A

Maximum number of Ballast

fnh3400D/AT (DSI Digital control) : 25
fnh3400X/AT (DALI Digital control) : 25

Wiring

* Core colours if using 5 & 6-core flex7 pre-wired plug and leads

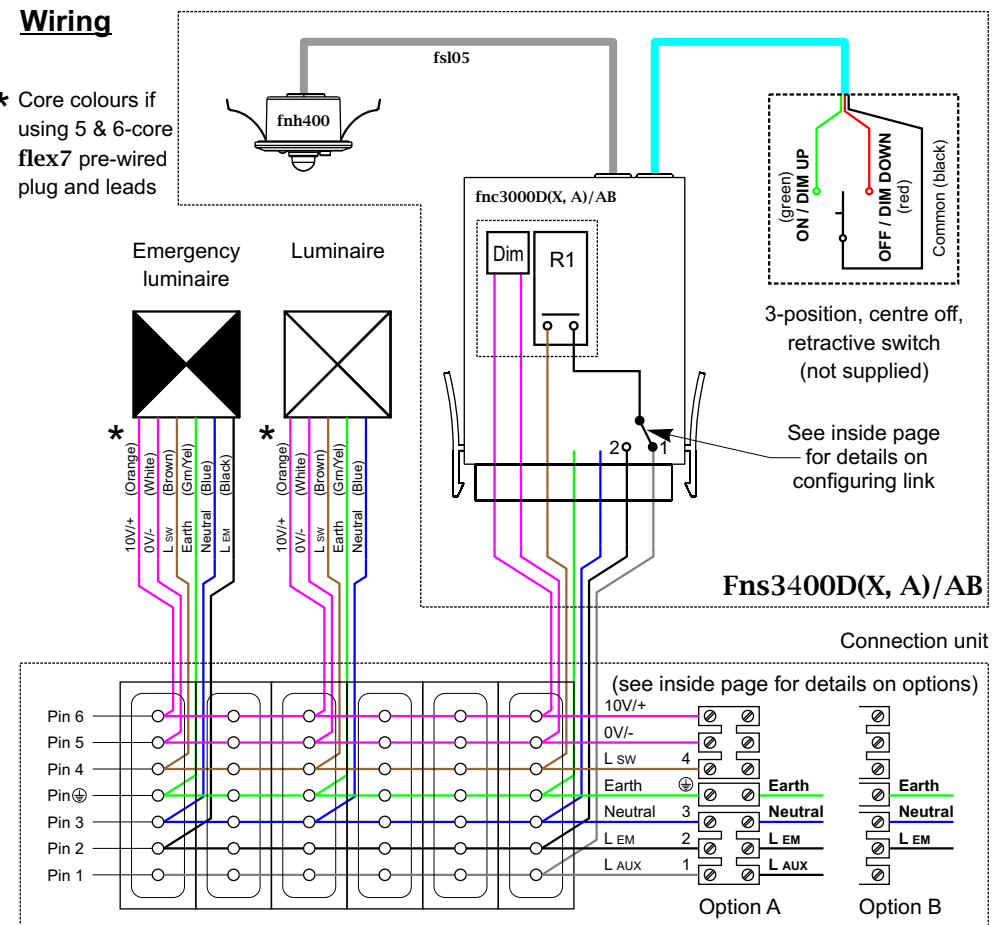

Operation:

Absence detection: When occupancy is no longer detected, lights will switch OFF after a pre-selected time-out period (default 20 minutes)

Daylight linking: Provided *daylight linking* is activated (see above) the light output will adjust to compensate for any changes in ambient light in order to maintain a constant light level under the sensor head, the *target-level*. **Note:** Alternative operational options not necessarily shown above are available using the frc/set setup remote control.

Switch control:

A short ON pulse (<0.5 secs) - turns the lights ON (to last dimmed level).
A short OFF pulse (<0.5 secs) - turns the lights OFF.

A long ON pulse (>0.5 secs) - brightens lights (eventually to maximum).
A long OFF pulse (>0.5 secs) - Dims lights (eventually to minimum).
A prolonged OFF pulse (>15 secs) - synchronizes the lights to OFF.

Note: Multiple switches can be connected in parallel. For each additional switch you will require:
1 x fsy/a - 'Y' adaptor
1 x fswXX - Switch drop lead (XX = length in metres in multiples of 5m)